

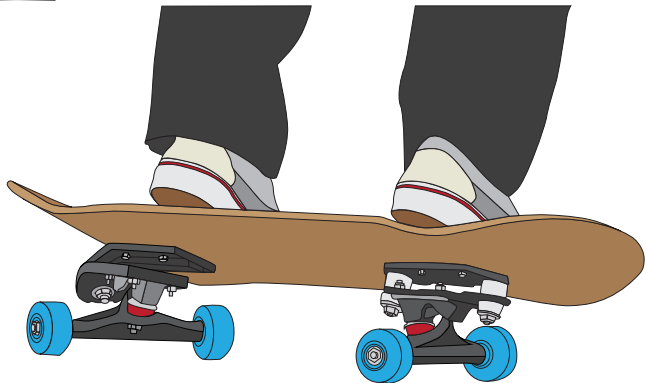

# **WATERBORNE SKATEBOARDS**

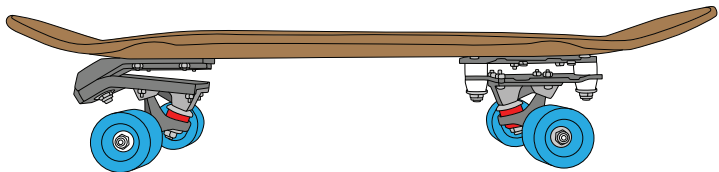

## **Waterborne Surf Adapter Assembly Instructions**



① Surf Adapter

② Rail Adapter

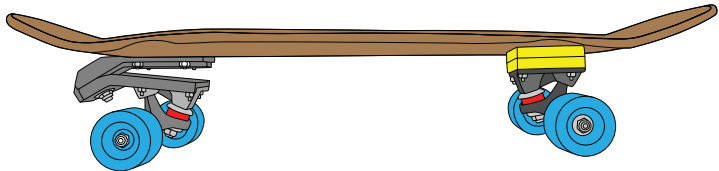

① Surf Adapter

③ Risers

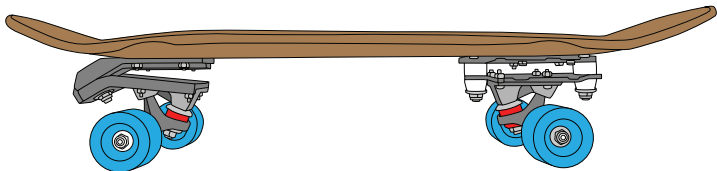

① Surf Adapter

② Rail Adapter

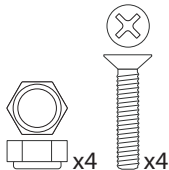
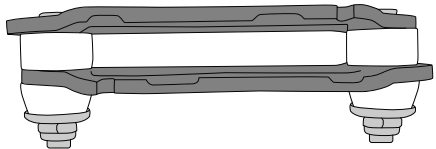
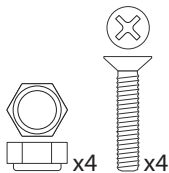
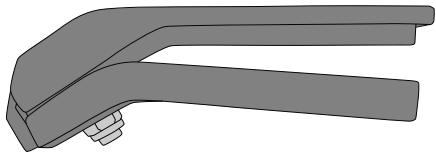

# Tools

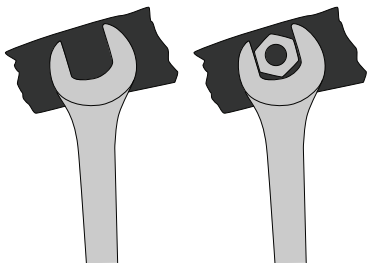
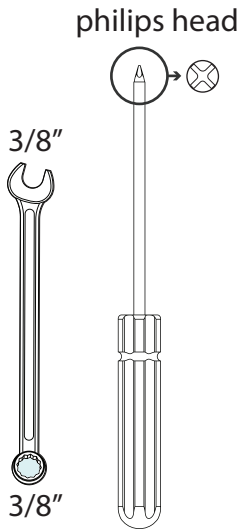

Tip: to help hold the nut in place while using the screwdriver to tighten, try putting a piece of tape on the open end of the wrench and sticking the nut in place. (tape not included). Fingers also work well too!

# TIPS

Note that the hardware in each bag is different. You can also use the hardware that was on your skateboard for attaching the deck to the adapters.

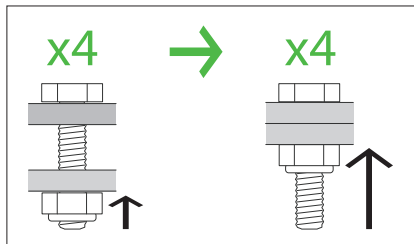
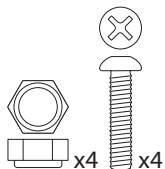
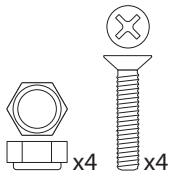
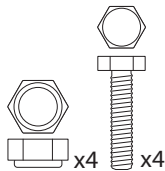
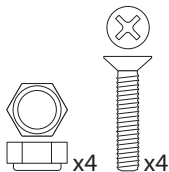

## Tip: Traditional kingpin

Note your truck alignment  
(take a photo of your skateboard before  
removing trucks)

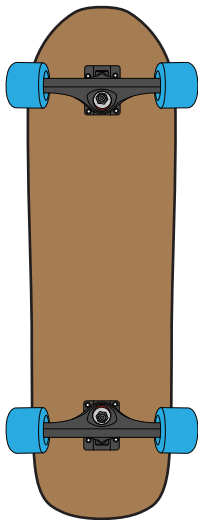

before

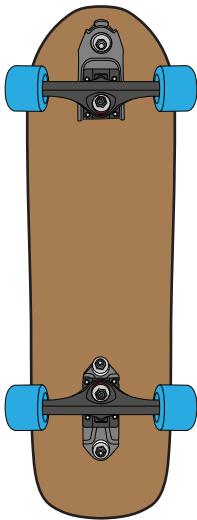

after

Tip: Reverse kingpin

Note your truck alignment  
(take a photo of your skateboard before  
removing trucks)

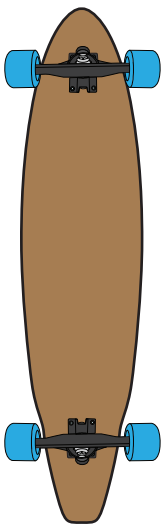

before

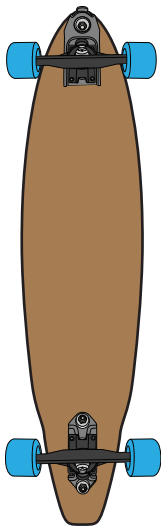

after

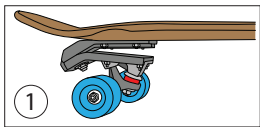

## 1.1 Prepare parts

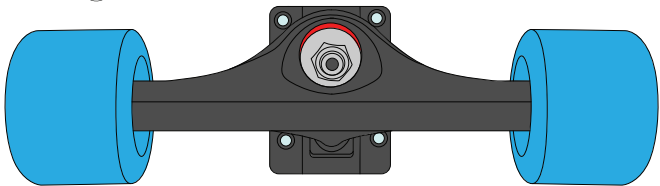
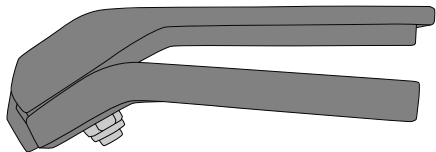
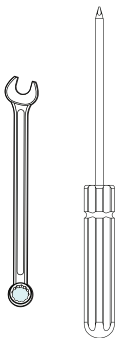
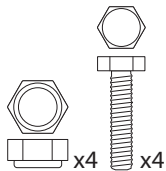



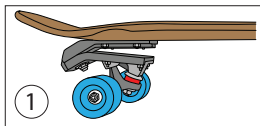

## 1.2 Insert Bolts

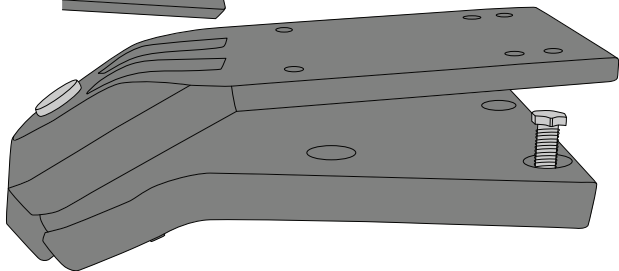
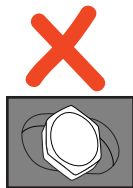
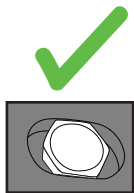
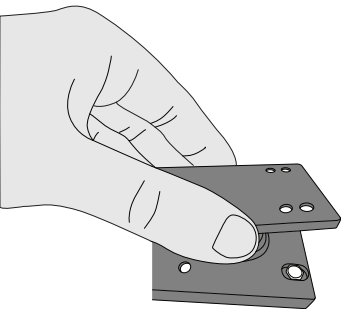
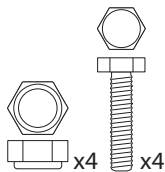

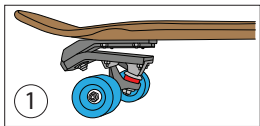

### 1.3 Attach Truck

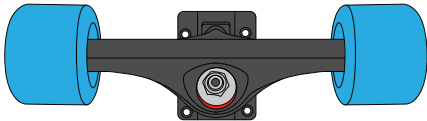
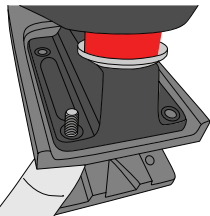
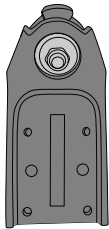

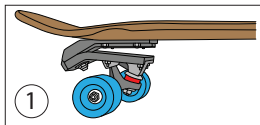

## 1.4 Tighten Bolts

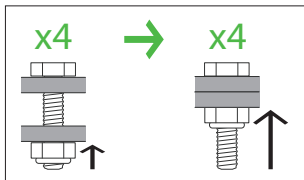
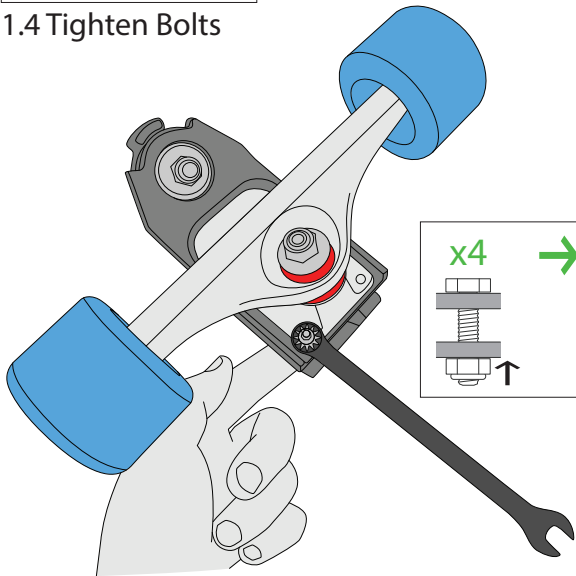

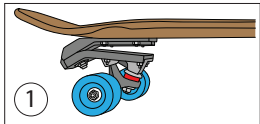

1.5 Align parts and prepare bolts

original hardware  
is also OK to use

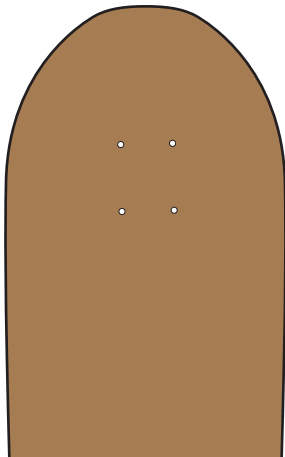
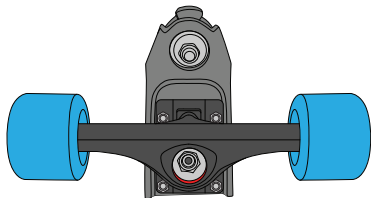
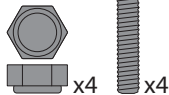

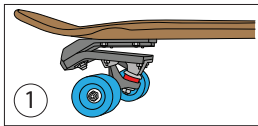

## 1.6 Choose correct bolt

original hardware  
is also OK to use

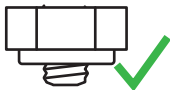
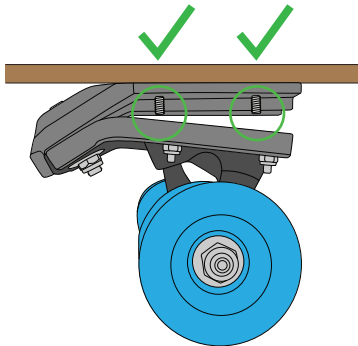
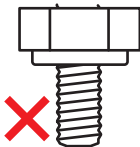
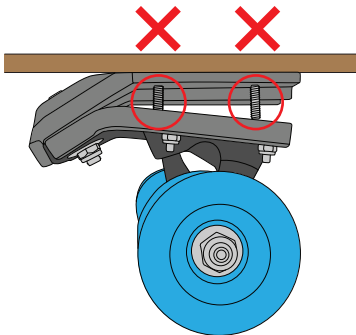

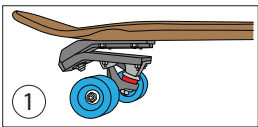

## 1.7 Tighten Bolts

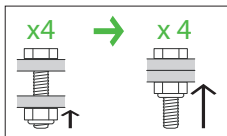
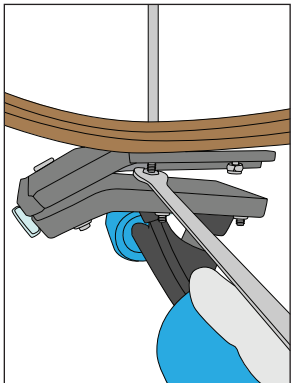
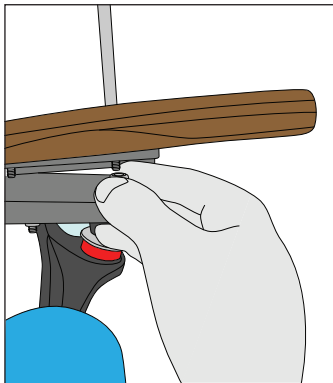

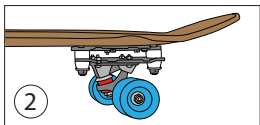

## 2.1 Prepare parts

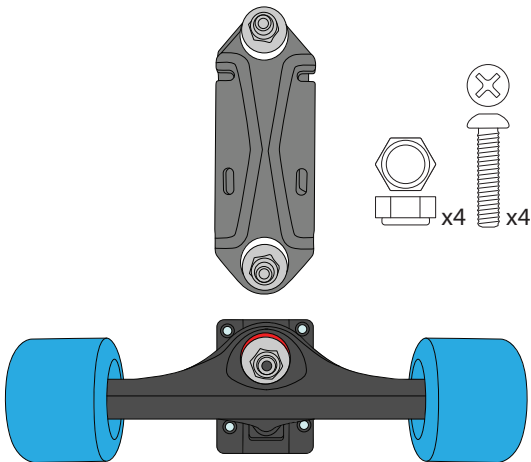

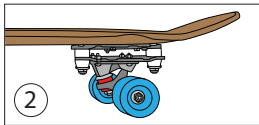

## 2.2 Align truck to Rail Adapter

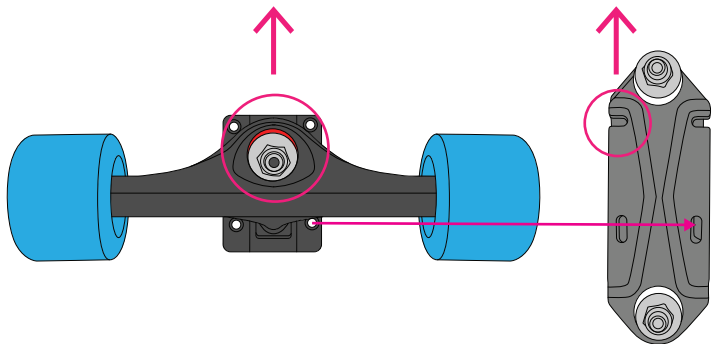



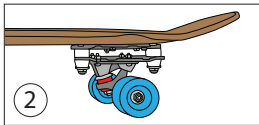

## 2.3 Tighten bolts

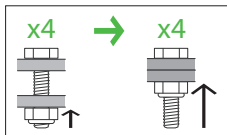
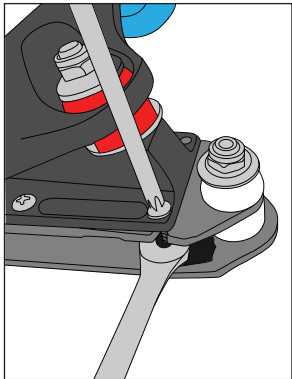
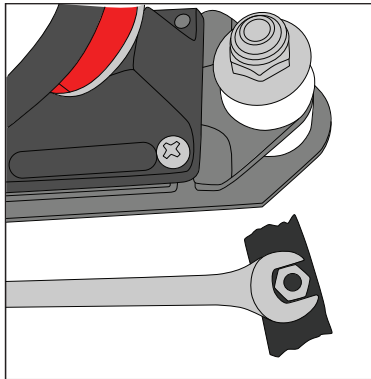

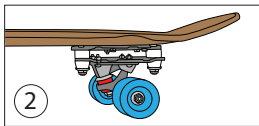

## 2.4 Align Rail Adapter+truck to Deck

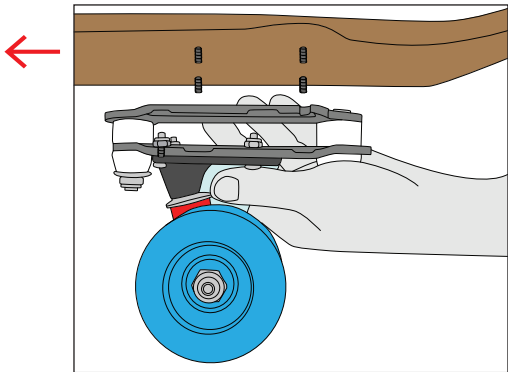
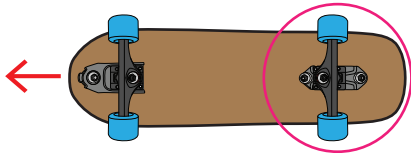

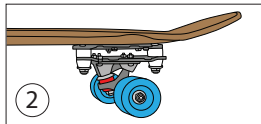

2.5 Tighten bolts

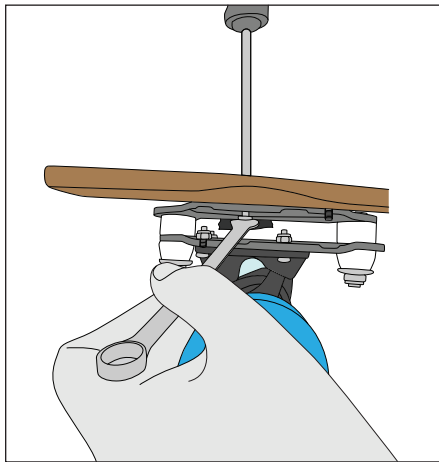
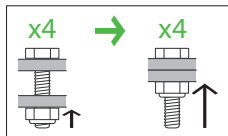

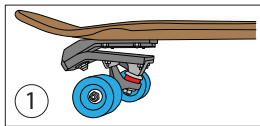

+

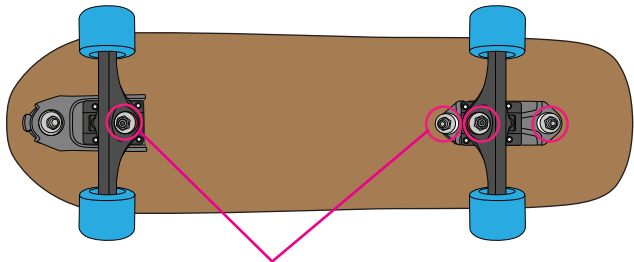
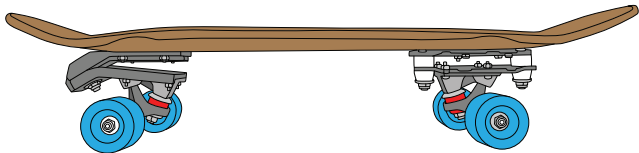
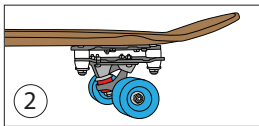

adjust as needed

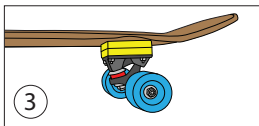

### 3.1 Prepare parts

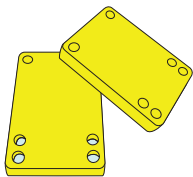

x4

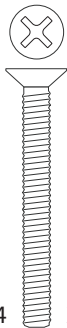

x4

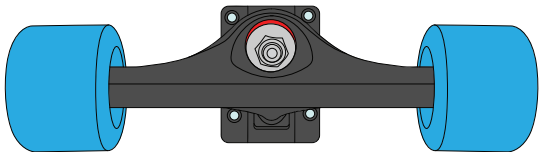

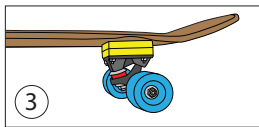

### 3.2 Insert bolts, align truck to deck

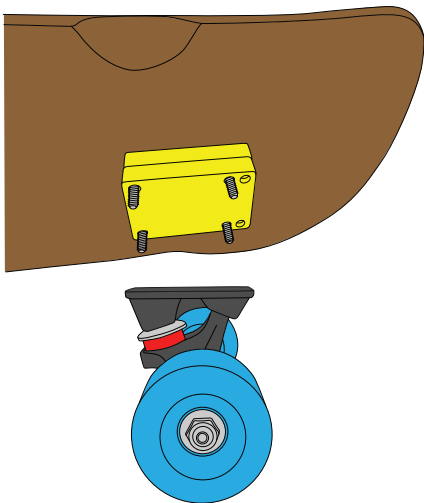

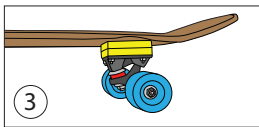

### 3.3 Tighten bolts

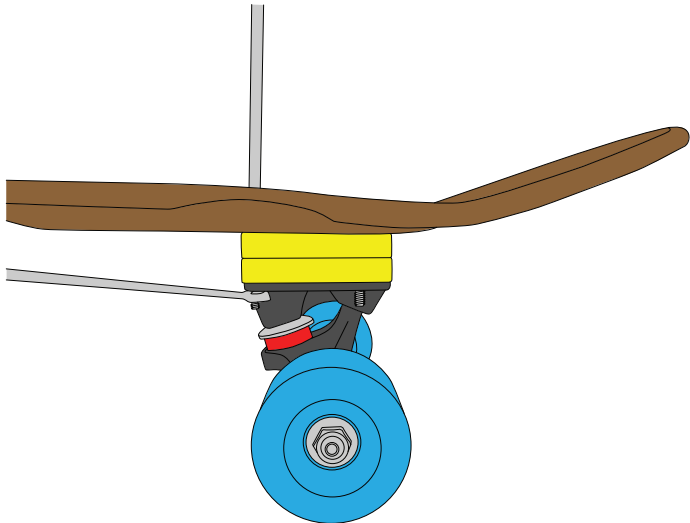
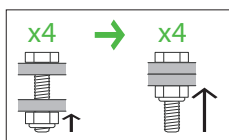

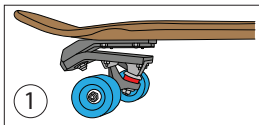

+

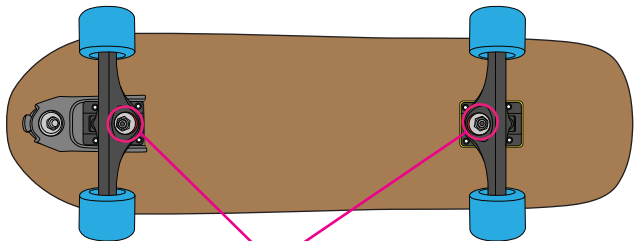
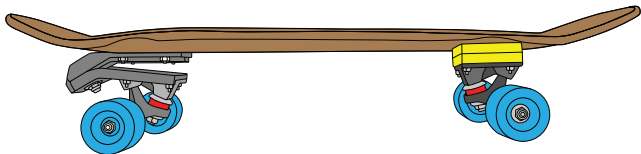
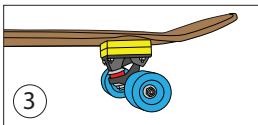

adjust as needed



extra page - use for.....

extra page - use for.....